

# Concrete Pillar Letterbox - Installation Instructions

The following instructions explain how to install your concrete pier.

**DO NOT** CONCRETE THE PIER LETTERBOX DIRECTLY INTO THE GROUND AS CONCRETE CAN SOMETIMES ADVERSELY REACT WITH THE RENDERED SURFACE OF THE PIER.

For some concrete piers, the front panel is stored inside the base cavity of the pier. Please check in here to retrieve the front panel.

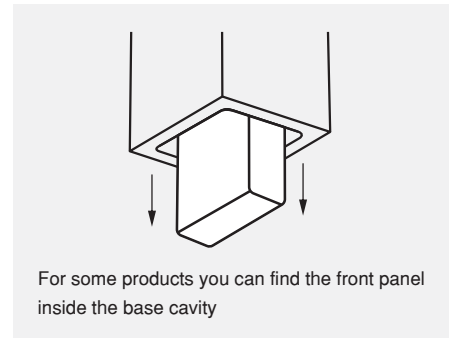

## OPTION 1: – LAY A CONCRETE PAVER

You will need:

- Concrete paver (approx. 45cm<sup>2</sup> square)
- Ready mix concrete
- Shovel
- Spirit level
- Adhesive (e.g. Liquid Nails Landscape)

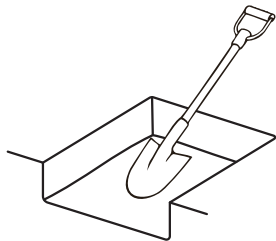

Dig a hole a about twice the depth of your paver.

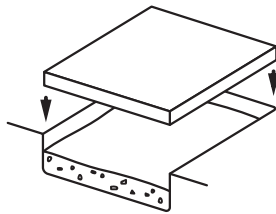

Mix up some concrete with water and fill half the hole.

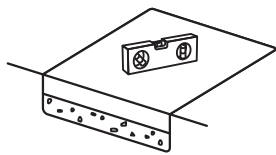

Place the paver onto the wet concrete. Check that it is level.

Leave for a minimum of 30 to 60 minutes for the concrete to partially set.

## OPTION 2: – POUR A CONCRETE PAVER

You will need:

- Ready mix Concrete (about 2 bags)
- Shovel
- Spirit level
- Adhesive (e.g. Liquid Nails Landscape)

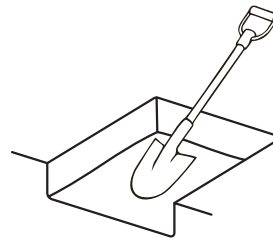

Dig a hole about 7cm deep and 45 to 50cm square.

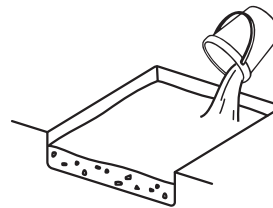

Fill the hole with freshly mixed concrete.

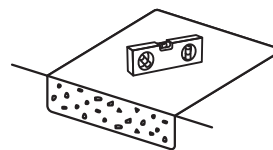

Wait for the concrete to fully dry before attaching the letterbox.

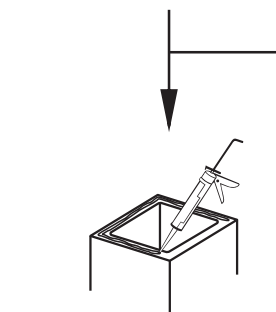

Apply a generous amount of adhesive such as 'Liquid Nails Landscape' to the base of the letterbox.

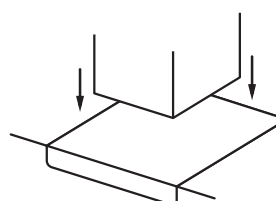

Place the letterbox into position.

