

Parcel Pal Installation and Instruction Sheet

Congratulations on purchasing the Parcel Pal letterbox. We have designed the Parcel Pal to offer a stylish, efficient and convenient way to have parcels delivered securely to your home. It also receives large A4 envelopes and offers excellent security for your mail and parcels. The rear door with key lock offers an easy and convenient means of retrieving your mail and parcels.

Installation

If you are using the Parcel Pal to receive parcels and general mail you will need to mount it in a location that is easily accessible to Australia Post. This will typically be at your front boundary.

If the Parcel Pal is used for receiving parcels only (i.e. you already have a letterbox for mail) then it can be mounted at any location that is readily accessible to a courier service.

Mounting onto existing concrete floor

- Place Parcel Pal in the chosen location and mark the mounting holes with a pencil

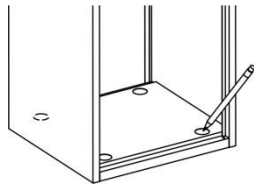

- Drill 4 holes (10mm diameter x 60mm deep) into the concrete floor for the mounting bolts

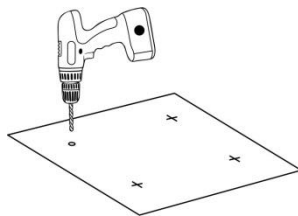

- Bolt the Parcel Pal to the concrete floor with the mounting bolts provided

Mounting onto ground

You will need to install a small concrete slab that is suitable for the Parcel Pal to be bolted onto

- Dig a hole approximately 450mm by 450mm and 100mm deep

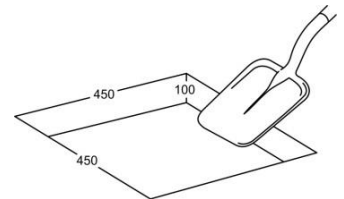

- Fill hole with concrete
- Use a spirit level to level the concrete and then leave it to set

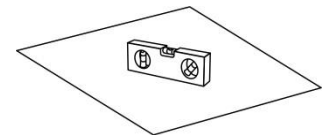

- Place Parcel Pal onto the concrete slab and mark the mounting holes with a pencil

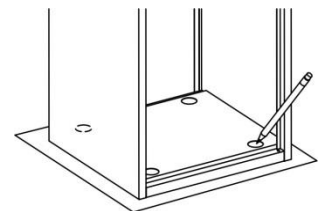

- Drill 4 holes (10mm diameter x 60mm deep) into the concrete slab for the mounting bolts

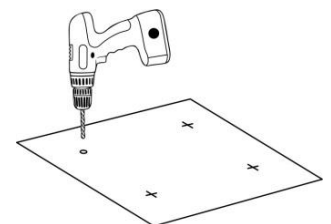

- Bolt the Parcel Pal to the concrete slab with the mounting bolts provided

Features

Accept A4 mail through a dedicated mail slot. Mail drops into the secure retrieval area

Rear door with key lock for easy, safe and convenient access to your parcels and mail

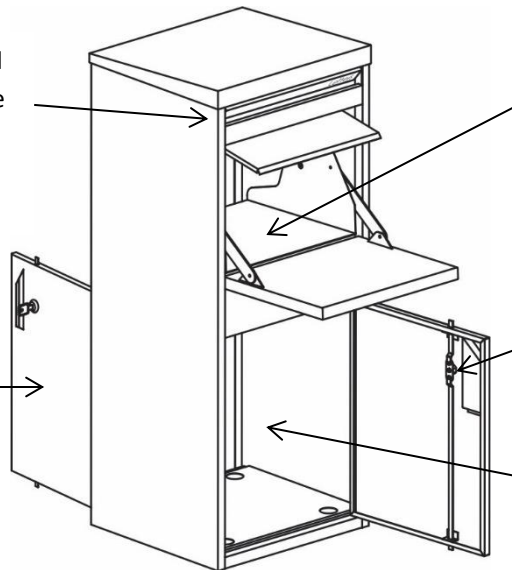

Medium sized parcels are delivered through the parcel chute.

Resettable combination lock for trusted courier access

Large parcels are delivered through the front door.

Using the Parcel Pal Letterbox

Medium Size Parcel Delivery

Parcels up to 24 x 25 x 36 cm (about the size of a carton of A4 paper) can be delivered via the top parcel chute. The delivery person simply pulls the door down, places the parcel inside and closes the door. The parcel will fall into the retrieval area at the bottom. A specially designed internal flap stops anyone from reaching into the retrieval area when the door is opened.

Fragile parcels should not be delivered this way.

Large Size Parcel Delivery

Larger parcels (e.g. a box of wine) need to be delivered via the lower door with the combination lock.

Most courier services have the provision for special delivery instructions to be included with a parcel. When you purchase an item that is to be delivered, let the supplier know the instruction for opening the combination lock.

For example the delivery instruction for a Parcel Pal with the lock code set to 321 could be:
"PLACE IN LETTERBOX. USE CODE 321 TO OPEN."

How to set your own Lock Combination

1. Set the combination lock to 0-0-0 (the factory setting) and unlock it
2. Find the small hole on the side of the lock for the code reset button
3. Using a paper clip push firmly through this hole to push down the code reset button
FOR THE FOLLOWING STEP DO NOT RELEASE THE PAPER CLIP. KEEP IT PUSHED IN FOR WHOLE STEP
4. Set the combination to your desired code
ONLY WHEN YOUR COMBINATION IS SET CAN YOU RELEASE THE PAPER CLIP
5. Your new code is now set. If you want to change the code, set the lock to your last code and repeat from step 2