

Fold Down Clothesline 7 Line

MCL13046

Contents

Your carton should contain the following parts:

2 x Wall Brackets	2 x Front Bars
2 x Telescopic Struts	1 x Front Brace
2 x Pivot Brackets	1 x Line Cord
2 x Side Arms	1 x Accessory Bag

Choosing a Suitable Location

Check that your chosen location has suitable side and front clearance. Allow 50cm side clearance and 100cm front clearance.

The recommended mounting height of the top slotted hole in the wall bracket is: **USERS HEIGHT + 110mm (11cm)**. Minimum height is 1.6m. See Detail A.

Installation and Assembly (Figure 1)

1. Mark position of wall brackets to a recommended overall width of 2400mm between centres. The width can be less than 2400mm if required, refer to Reducing the Overall Width.
2. Attach the wall bracket to your brick wall or timber posts as shown in Detail A.
 - For brick walls use M8 (10mm) masonry anchors (not provided)
 - For timber posts use M10 coach screws (not provided)
3. Ensure the two parts of each strut are assembled as shown in Figure 3
4. Fit Square End Caps to telescopic struts and attach to the wall brackets through the bottom holes using the 60mm coach bolts provided.
5. Fit the Line Tensioner to the front of the right hand side arm. Detail D shows the Line Tensioner.
6. Fit the Pivot Bracket to the side arm using the 40mm coach bolts provided. Tighten all nuts firmly.
7. Fit the Rectangle End Caps to the ends of the side arms.
8. Fit the side arms to the top hole of the wall brackets using 60mm coach bolts provided. Fit the free end of the telescopic struts to the pivot brackets on the side arms using the 30mm Coach bolts and nuts provided.

Reducing the Overall Width

If your available space doesn't allow the full 2400mm width, you can reduce the width of your Clothesline as follows:

- For this example, we are assuming your required overall width is now 2000mm
- This is a reduction of $2400 - 2000\text{mm} = 400\text{mm}$
- Cut half of this from each side of the 2 x cross bar segments $400 / 2 = 200\text{mm}$ each side

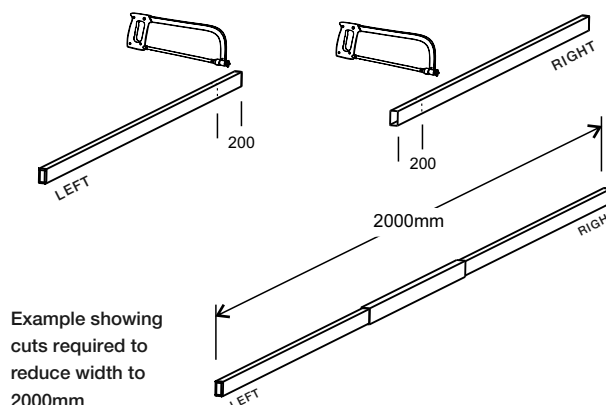

9. Assemble the front bar as shown in Detail B. Push the left and right bars fully into the centre bar until they hit the small indent in the middle of the centre bar.
10. Spread the side arms slightly apart and insert the assembled front bar into the corners as shown in Figure 1.
11. Lift clothesline until the struts both click once to indicate it has locked into position, then lower gently into the horizontal position. To release, lift the front bar up until you hear both struts click, then lower gently.

Line Cord Installation

1. Ensure the Line Tensioner is at the front of the right hand side arm
2. Start threading the cord through the left side arm hole nearest the wall bracket as shown in Figure 2. Tie off the end as shown in Detail C.
3. Progressively tighten each line, starting from the rear, working towards the front. Don't over-tighten or you will distort the side arms.
4. Thread the cord through the Line Tensioner as shown in Detail D. Lift the clamping lever up before threading the cord. Push the lever down to clamp the cord.

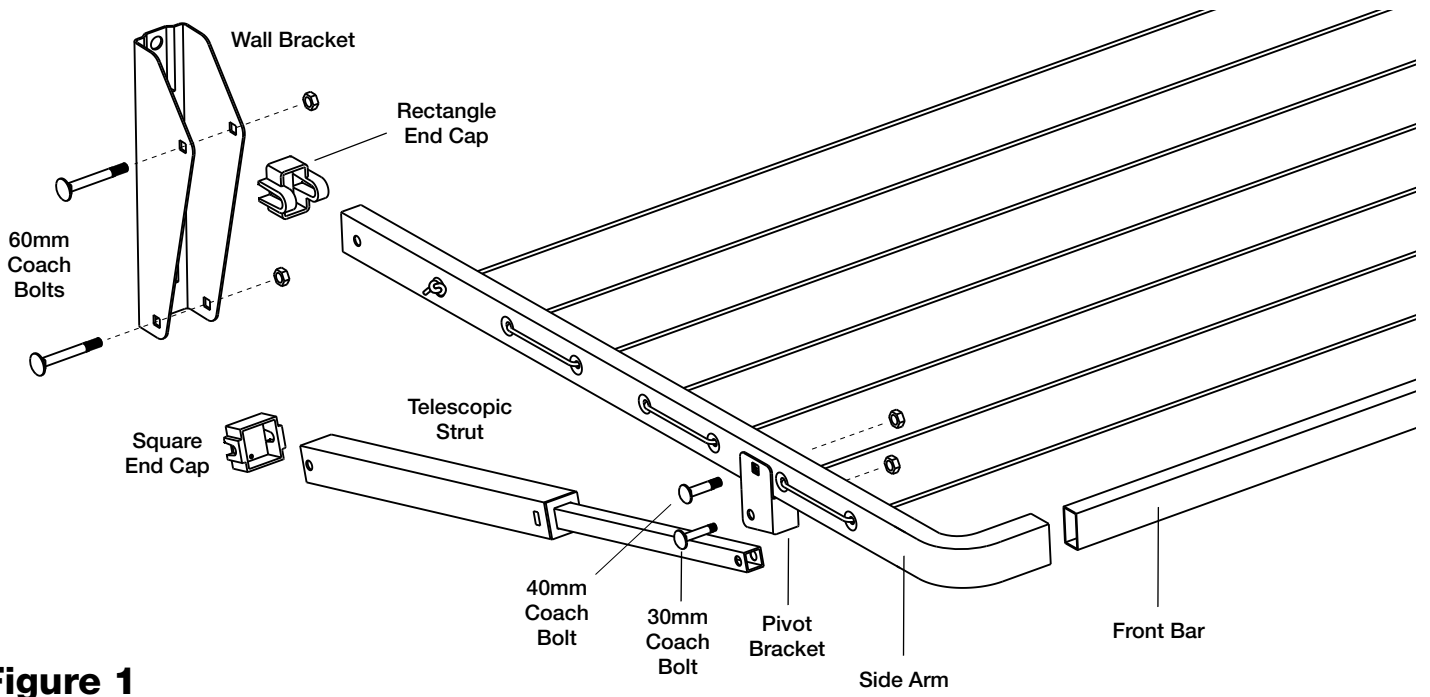
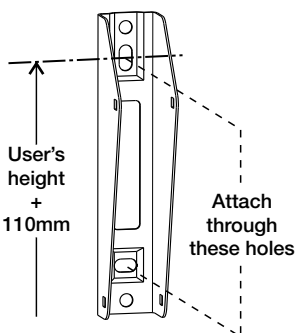
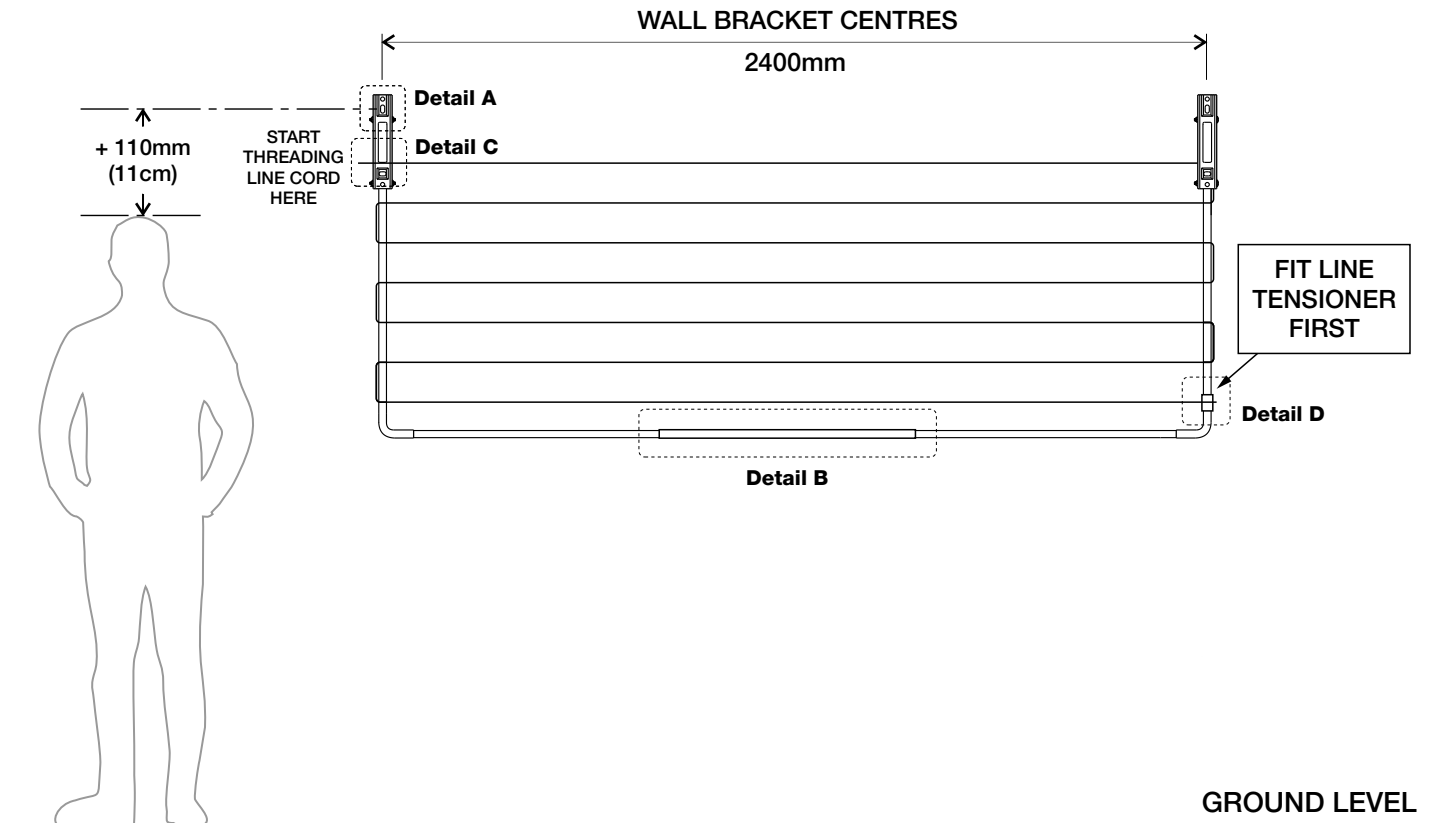
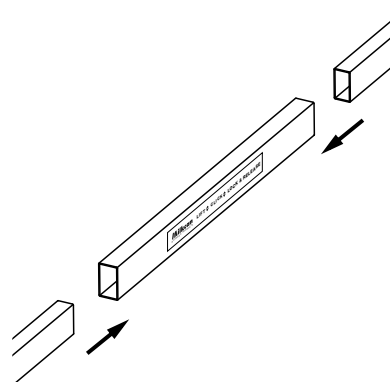

Figure 1

Figure 2



Detail A



Detail B

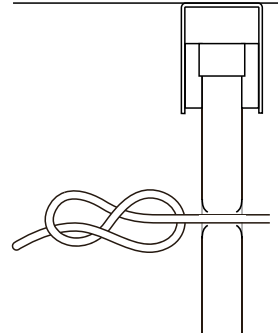

Detail C

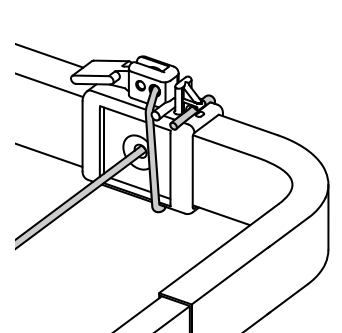

Detail D

Figure 3

HOW TO ASSEMBLE THE TELESCOPIC STRUT

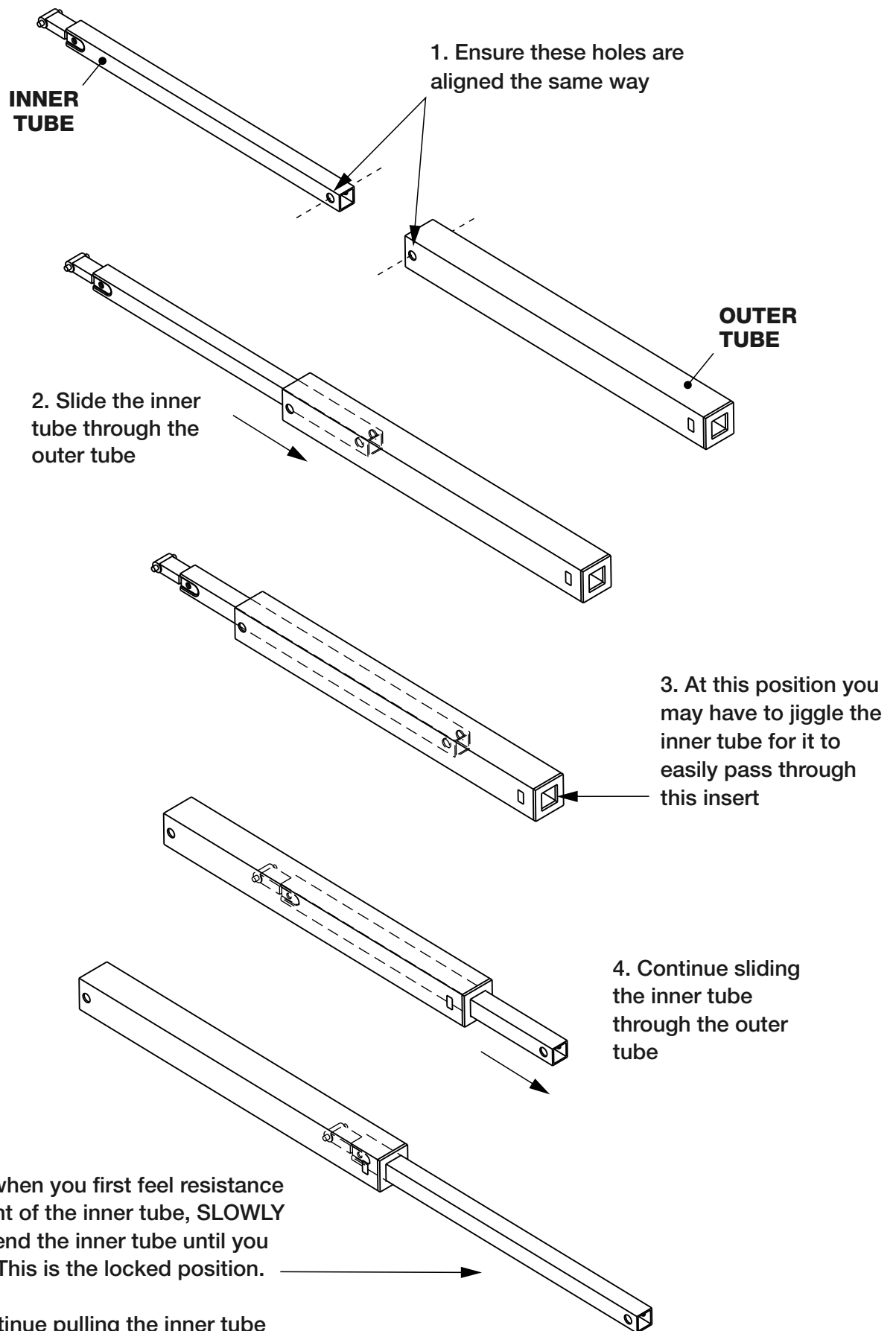

To unlock - continue pulling the inner tube outwards until you hear another click - this is the unlocked position.

NOTE

You must extend the inner tube slowly to set it to the locked position. If you pull the inner tube out too quickly it will go straight through to the unlocked position.